

**theben**309952 02
23.04.2024**EN Digital clock thermostat**

RAMSES 811 top3
 8119200
RAMSES 812 top3
 8120200
RAMSES 812 top3 16A
 8120210
RAMSES 813 top3 HF
 8139200
RAMSES 813 top3 HF Set 1
 8139201
RAMSES 813 top3 HF Set A
 8139203



1. General information

- Digital clock thermostat for wall mounting or mounting on flush-mounted box
- The clock thermostat conforms with EN 60730-2-9 if correctly installed
- The RAMSES top3 series consists of 2 battery devices (8119200, 8139200) and 2 power supply devices with relay output of 10 A/16 A (8120200, 8120210)
- External input to connect an external temperature sensor, floor sensor etc. (only 8119200, 812xxxx, 8509200)
- Radio-controlled system RAMSES 813 top3 HF Set 1 and Set A consisting of RAMSES 813 top3 HF and receiver
- The RAMSES top3 app (for Android, iOS) allows settings via mobile devices
- Direct Bluetooth Low Energy (BLE) connection between app and RAMSES top3 devices
- Optional accessories: Floor sensor (9070321), Temperature sensor RAMSES (9070459)

2. Safety



Assembly and installation should only be carried out by a qualified electrician, somebody who has completed appropriate professional training and has the knowledge and experience necessary to be able to recognise and avoid the potential dangers posed by electricity.



Before installation/disassembly, disconnect the supply voltage and ensure that the parts are no longer live.



Prior to commissioning and using the product, read and observe all the operating instructions.

3. Proper Use

- Digital clock thermostat for time-dependent monitoring and control of the room temperature in single-family houses, offices, etc.
- Only operate the devices in dry indoor rooms (no bathrooms, etc.)

4. Installation

You can mount the clock thermostat either on the wall (not 8120210) or on a flush-mounted box.

Batteries

The devices RAMSES 811 top3 and RAMSES 813 top3 HF are battery devices.

- Only use AA batteries LR6, 2 x 1.5 V.
- Ensure correct polarity.

Mount the clock thermostat

① For wall mounting. With RAMSES 813 top3 HF, a stand is also included in the set.



Protect the clock thermostat from moisture, dust, direct sunlight, thermal radiation and draughts.



On the battery devices (8119200 + 8139200), the terminal box cover plate must be fixed with the screws.

- Position the clock thermostat on an interior wall, at about eye level (approx. 1.50-1.60 m).

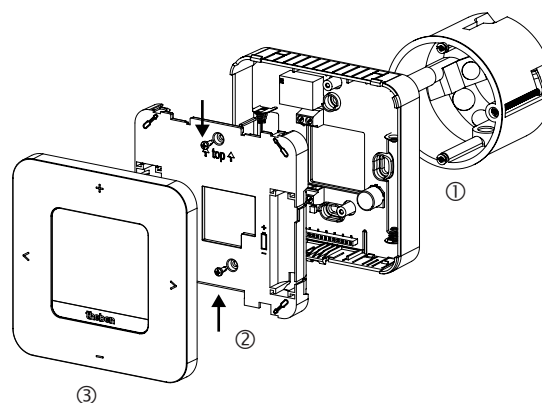

- Fix the mounting plate directly to the wall or to a flush-mounted box using the holes ①.
- Assign and wire the conductors.
- Insert the terminal box cover plate (top must point upwards).
- If necessary, tighten the screws and insert the batteries correctly (only with 8119200 + 8139200) ②.
- Put on the clock thermostat ③.

Dismount the clock thermostat



For battery change, open the device according to the illustration, as it could be destroyed if not done so.

- Insert the screwdriver into the opening and push up slightly to open the device.

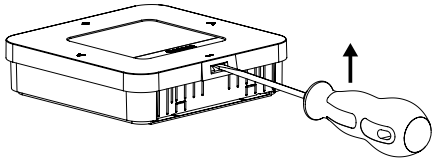

5. Connection

Power is supplied via L and N (see technical data); the connection to the boiler is made via a relay contact.

- ⚠ Secure device (8119200 + 8120200) with an upstream type B or type C circuit breaker (EN 60898-1) with a maximum of 10 A.
- ⚠ The external input is active, therefore do not use external voltage. The connected contact must be floating. At 8120200, the input is not safely separated from the mains, therefore only connect insulated components.
- ⚠ Disconnect the boiler from mains supply before connecting the thermostat.
- ⚠ In order to eliminate the possibility of EMC interference, always lay the mains supply feed separate from the external input (if one is being used).
- ⚠ Faulty connections will damage the device.

RAMSES 811 top3

- ① External sensors such as a floor sensor (9070321) or a temperature sensor (9070459) can be connected to the external input (ext. input).

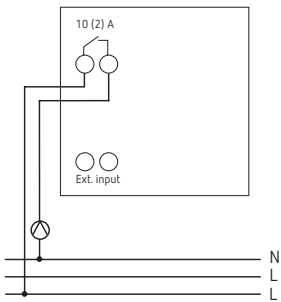

RAMSES 812 top3

- ⚠ At 8120200, the external input is not safely separated from the mains, therefore only connect insulated components.

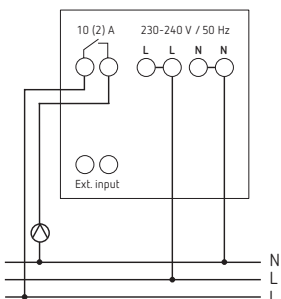

RAMSES 812 top3 16A

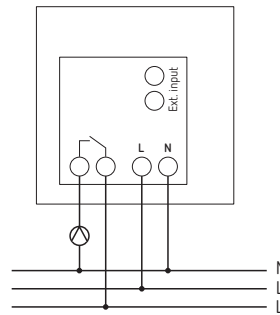

RAMSES 813 top3 HF

- ① RAMSES 813 top3 HF and various receivers provide a radio-controlled system for room temperature control.

The following sets are available:

1. RAMSES 813 top3 HF Set 1

Set 1: 1 x RAMSES 813 top3 HF with receiver REC 1 (1 channel)

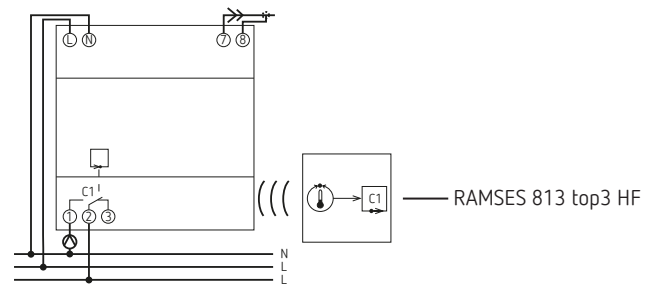

Receiver REC 1

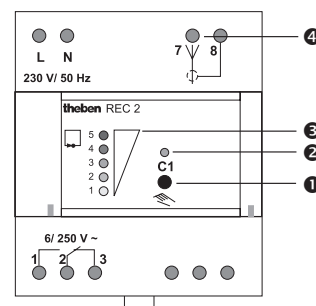

- ① Button channel 1
- ② Status display channel 1
- ③ Level display for reception quality
- ④ Antenna connection

2. RAMSES 813 top3 HF Set A

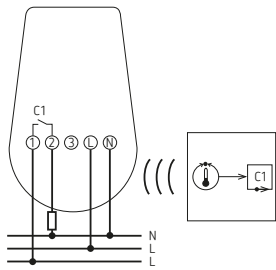

Receiver REC 11

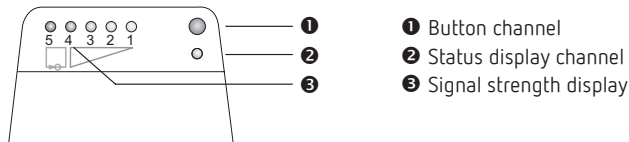

① The clock thermostat and REC receiver are ready for operation when delivered, i.e. they are matched to each other and coded. Recoding is not necessary for common applications!

Information on how to connect a new receiver to RAMSES 813 top3 HF – if the existing unit is defective – can be found at Page 12.

6. Settings at the clock thermostat

Symbols on the display

① Depending on the device type, different symbols may appear on the display.

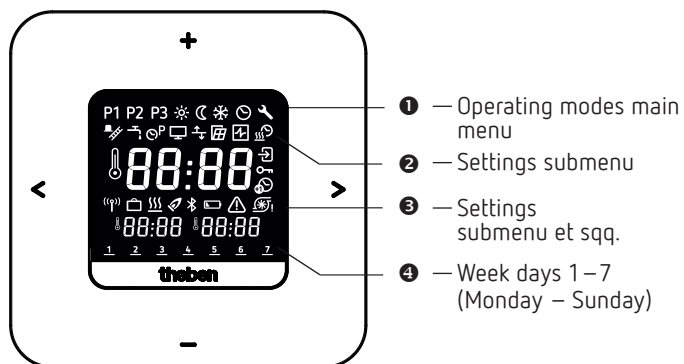

< > • Browsing the display
• Confirm selection (>) or go back one step (<)

+/- • Set values
• Select using +

7. Menu

Operating modes main menu

- P1 P2 P3** Weekly programs P1 – P3
- Comfort temperature
- Setback temperature (Eco)
- Frost protection temperature
- Set date and time
- Service/Settings

Settings submenu

- Change weekly programs P1 – P3
- Customise display
- Set wall compensation (offset)
- Select window detection
- Select controller
- Set the optimisation function
- External input
- Enter/change PIN
- Set summer/winter time
- Set pump protection
- Fault
- Battery status (only 8119200, 8139200)
- Bluetooth
- Heating active
- Holiday program
- Wireless (teach-in HF connection) (only 8139200)

How does my clock thermostat work?

Your clock thermostat regulates your room to the desired temperature at set times. You can set 3 weekly programs (P1 – P3). In addition, you can define and activate the temperatures of the operating modes (comfort, setback and frost protection function):

- Comfort temperature: is usually used for the day, i.e. when you are present.
- Setback temperature (Eco or energy saving temperature) for the night.
- Frost protection temperature: is used for periods of prolonged absence (e.g. holidays). The temperature is just high enough to protect the heating system from frost.

TIP

The easiest and quickest way to operate the clock thermostat is with the RAMSES top3 app!

8. Initial operation

① The summer/winter time rule for Central Europe is preset.

After the RAMSES top3 devices have been mounted and connected and the batteries have been inserted in 8119200, 8139200, the date/time and – if desired – a different summer/winter time have to be entered.

Enter date and time

① The date and time setting can be skipped when connecting to the app. The clock thermostat then adopts the time and date of the mobile device.



- Use +/– to enter the desired hour.
- Confirm with >.
- Use +/– to enter the desired minute.
- Confirm with >. The year appears.
- Confirm the year with >. The two digits for the month on the right flash.
- Enter the month with +/–.
- Confirm with >.
- Enter the day with +/–.
- Confirm with >.

The device is now ready for operation. The display shows the weekly program P1, the actual temperature, the set temperature at the bottom left and the current time at the bottom right.

① Date and time can also be changed in the  main menu.

If you purchased a wireless clock thermostat (8130200), then after entering the time and date, you must connect the unit to the receivers, see Page 11.

Enter a different summer/winter time

You can change the summer/winter time under Settings  →  (see Page 7).

Change set temperature briefly

① The changed set temperature is not saved in the program and will be replaced by the next programmed switching time. This also applies when the programs P1 – P3 are active.

If the comfort, setback or frost protection temperature is active, the changed set temperature applies permanently.

- Press > to access the main menu.
- Press + here. The set temperature flashes.
- Use +/– to enter the desired set temperature.
- Confirm with >.

1. Main menu: Set/change operating modes



- Scroll through the main menu with > (or back with <).
- Use + to select the desired function.
- Change the value with + or –.
- Confirm with >.



Programs P1 – P3

There are 3 preset weekly programs available:

	Mon	Tue	Wed	Thu	Fri	Sat	Sun
P1							
06:00 (21 °C)	←————→						
22:00 (17 °C)	←————→						
07:00 (21 °C)						←————→	
23:00 (17 °C)						←————→	

	1	2	3	4	5	6	7
P2							
06:00 (21 °C)	←————→						
08:00 (17 °C)	←————→						
16:00 (21 °C)	←————→						
22:00 (17 °C)	←————→						
07:00 (21 °C)						←————→	
23:00 (17 °C)						←————→	

	1	2	3	4	5	6	7
P3							
12:00 (21 °C)	←————→						
20:00 (17 °C)	←————→						
07:00 (21 °C)						←————→	
22:00 (17 °C)						←————→	

- Select the desired programme with >.
- Confirm with +.
- If you want to change the program (switching times), you can do this under Settings  → .

Comfort, setback and frost protection temperature

You can select these 3 operating modes and change them if necessary.

- Select the desired preset program with >.
- Confirm with +.
- Use + or – to set the desired value.
- Confirm with >.

2. Submenu: Settings



In the submenu **Settings** , programs, display, wall compensation, PIN, controller, pump protection, etc. can be set.

- Press > 2 x and go to Settings  with >.
- Confirm with +. The flashing Bluetooth symbol appears.

Bluetooth

When the Bluetooth symbol  flashes, the clock thermostat can connect to the **RAMSES top3** app on your smartphone or tablet (see Page 7).

- ① If the Bluetooth symbol appears permanently in the display, the device is connected to the app.
- ① If the button  is pressed for 8 s, all connection data will be deleted.

Or skip Bluetooth and

- press >. You can now enter the 4-digit PIN  (default: 0000) using + or -.
- Confirm each digit with >. You will then be in the Settings submenu.



- ① If you forgot the correct PIN, press + for 30 s (reset). The PIN is now set to 0000 for 5 min and you can enter your password. If you do not enter the password during this period, the old password becomes active again.

Only now you can change the following functions in the Settings submenu :

1. Change/check/delete weekly programs P1 – P3

The preset programs can be changed and deleted.

- ① 42 switching times can be changed.

If you want to change the program or switching times, you can do this under Settings  → .

- Use > to go to Settings. The menu  flashes.
- Use + to select the program P1, P2 or P3.
- Confirm with >. The display shows, for example, P1 .



Check/change switching times of P1

- By pressing > you can check the switching times that have been entered.
- Use + or - to change the values and confirm with >.
- Press + or - 2 x and select the switching time, then enter the desired value with + or - and confirm with >.
- Use < > to change the time, the day of the week or the temperature.
- Carry out the steps as described above for programs P2, P3.
- Use < to exit the menu P1.

Delete switching times

- Select the switching time to be deleted and go to --:-- with + or - (between 23 : xx and 00: xx o'clock).
- Confirm with >. The switching time is deleted.
- To delete further switching times, carry out the above steps.



2. Customise display

You can customise your display (in operating mode) under Settings  → .

- Rotate using + or - actual temperature, set temperature and time to obtain the desired display.
- ① You can also adjust the display brightness with + or - (from - to ----) and set the backlight duration (e.g. 0:30 min:sec).
- ① For battery devices, low brightness and short duration are recommended – the batteries will then last longer.



3. Set wall compensation

If the installation location is unfavourable, this may lead to variations in temperature between the detected and actual room temperature (e.g. at an outer wall that is too cold or an inner wall that is too warm). This difference can be corrected by using the wall compensation.

- Under Settings  →  use + or - to adjust the measured temperature by - 3 °C to + 3 °C.
- Confirm with >.



4. Select window detection

If this function is active, the clock thermostat detects the temperature drop if the window is opened at a cold outside temperature. The heating process is stopped for 15 min to save energy (it will be regulated to frost protection temperature).

- Under Settings  →  use + or - to switch the function on or off (ON, OFF).
- Confirm with >.

5. Select controller

This function allows you to select 2 different controllers:
1 → Pulse duration controller, 2 → Hysteresis controller.

- Under Settings  →  use + or - to select controller type 1 or 2 (default: hysteresis controller).

Pulse duration controller

- ① Amplitude of the controller triangle adjustable from 0.2 K to 5.0 K; period duration adjustable from 5 – 30 min; controller offset adjustable from 0.0 °C to 2.0 °C

- Use + or - to select function 2.
- Confirm with >. This takes you to the entry of the period duration.
- Use + or - to enter the amplitude.
- Confirm with >.
- Set the period duration with + or - and confirm with >.
- Set the offset of the controller with + or - and save with >.

Response

In adapted heating systems, a pulse width controller is characterised by short regulation time, low overshoot and thus high regulation accuracy.

General function

A triangle line is calculated which is positioned centrally around the specified set temperature. The triangle is calculated from the period and the amplitude.

As long as the triangle value is greater than the actual temperature, heating takes place. If the triangle value is smaller than the actual temperature, heating does not take place. The higher the actual temperature, the shorter the duty cycle.

Examples for settings

Amplitude	Period duration	Heating	Room properties
0.2 K ↓	5 minutes ↓	<ul style="list-style-type: none"> Fan heater systems oversized heating systems in relation to room size any fast heating system that can quickly deliver a lot of energy into a room fast mixing valves 	<ul style="list-style-type: none"> small room very good insulated rooms for all rooms, which, due to their design respond quickly and extremely to switching the heating on/off
1.0 K ↓	10 minutes ↓	<ul style="list-style-type: none"> fast mixing valves Central heating systems with for example radiators slow mixing valves 	<ul style="list-style-type: none"> medium sized rooms large, poorly insulated rooms
2.5 K ↓	20 minutes ↓	<ul style="list-style-type: none"> slow mixing valves Underfloor central heatings Quartz radiators Wall and ceiling heating systems slow or inert heating systems 	<ul style="list-style-type: none"> large rooms that need much time to warm up and cool down just as slowly
5.0 K	30 minutes		

Hysteresis controller (2-point control)

- ① Hysteresis adjustable from 0.2 K to 1.0 K.
- Use + or – to select function 1.
- Confirm with >. This takes you to the entry of the hysteresis.
- Use + or – to enter the hysteresis.

Response

In over or undersized heating systems, a hysteresis controller is characterised by a minimum switching frequency and low temperature deviations.

Function

The clock thermostat switches the heating off when the set temperature plus amplitude value is exceeded. The clock thermostat switches the heating on again when the temperature falls below the set temperature minus the amplitude value.

6. Set the optimisation function

The optimisation function allows you to achieve a certain room temperature at a desired switching point. It is indicated how many minutes earlier the heating starts. This time applies per K of temperature difference between actual temperature and desired set temperature.

Example

At 06.00 a.m. in the morning, a change in the bathroom is programmed from reduction (17 °C) to comfort temperature (23 °C).

Without optimisation function, the room thermostat enables the heating request for the bathroom at 06.00 a.m. Depending on the size of the room and the installed heating system, the bathroom reaches the desired 23 °C at 6.30 a.m., for example.

With a set optimisation of 5 min/K, the thermostat sends the heating request earlier, as follows:

Set temperature at 06.00 a.m. → 23 °C
 Actual temperature → 17 °C
 i.e. Delta T = 6 K
 $6 \text{ K} * 5 \text{ min/K} = 30 \text{ min}$

The controller sends the heating start 30 min. earlier and reaches the setpoint temperature at 06.00 a.m.

- ① The optimisation value depends on the spatial and heating conditions.

- Under Settings → use + or – to select the optimisation function.
- Use + or – to set the time from 1 min to 60 min or OFF and confirm with >.

7. External input

The external input can be configured for various external sensors.

- ⚠ The external input is active, therefore do not use external voltage. The connected contact must be floating. At 8120200, the input is not safely separated from the mains, therefore only connect insulated components.

- ① RAMSES 813 top3 HF does not have an external input.

- Under Settings → use + or – to select the external input.
- Use + or – to set one of the 6 options and confirm with >.

The following options are available with the individual sensors/contacts:



- 0 → inactive
- 1 → floor
- 2 → external temperature sensor
- 3 → presence detector
- 4 → window contact
- 5 → telephone contact

Floor	Temperature limit	Floor temperature restriction, floor temperature selection adjustable between 20 °C and 50 °C; floor sensor (9070321) ① No safety temperature limiter, but device type 1 B in accordance with EN 60730-1.
External temperature sensor	no options	The internal temperature sensor will be switched off; external temperature sensor (IP 65) (9070459).
Presence detector	Temperature selection	This temperature is used for control if the HVAC output of the presence detector is switched. If no presence is detected, the set program is used for control.
Window contact	no options	As long as the window contact is open, the thermostat controls to frost protection temperature.
Telephone contact	Temperature selection	Select temperature for the controller if the telephone contact is switched.

8. PIN

This function can be used to assign a new PIN.



① The factory setting for the PIN is 0000.

- Under Settings  →  use + or – to select the PIN.
- Enter the 4-digit PIN with + or –.
- Confirm each digit with >.

9. Change summer/winter time

Here you can set a different summer/winter time.

① The summer/winter time for Central Europe is preset.

- Under Settings  →  use + or – to select the summer/winter time from 0–3.

You can choose between

0 → **Inactive** (no summer-winter time changeover)

1 → **Central Europe** (default):

Changeover from winter time to summer time on the last Sunday in March at 2 o'clock (at 2 o'clock the clock is set forward by one hour to 3 o'clock)

Changeover from summer time to winter time on the last Sunday in October at 3 o'clock (at 3 o'clock the clock is set back one hour to 2 a.m.)

2 → **Western Europe**:

Changeover from winter time to summer time on the last Sunday in March at 1 o'clock (at 1 o'clock the clock is set forward by one hour to 2 o'clock)

Changeover from summer time to winter time on the last Sunday in October at 2 o'clock (at 2 o'clock the clock is set back one hour to 1 a.m.)

3 → **Eastern Europe**:

Changeover from winter time to summer time on the last Sunday in March at 3 o'clock (at 3 o'clock the clock is set forward by one hour to 4 o'clock)

Changeover from summer time to winter time on the last Sunday in October at 4 o'clock (at 4 o'clock the clock is set back one hour to 3 a.m.)

10. Set pump protection

The pump protection is a function that switches 1 x per week to protect the pump from seizing up.

① If pump protection is activated, the heating circuit pump is switched on for one minute every Wednesday at 11:30 a.m.



- Under Settings  →  use + or – to select On or Off (default).

11. Holiday program

The holiday program can only be set via the RAMSES top3 app. If the holiday program is set, the display of the clock thermostat shows the symbol .

12. Wireless

With the RAMSES 813 top3 HF, you can connect your receivers wirelessly.

Under Settings  →  select the wireless symbol. If the symbol flashes, the device can be connected to the receivers (see Page 11).

Fault

In the event of a fault or error, the error code flashes on the display. The warning triangle  also flashes. All other display symbols are cleared.

Error code	Explanation
401	Error external temperature sensor, sensor breakage
402	Error external temperature sensor, sensor short circuit
403	Error room temperature sensor, sensor breakage
404	Error room temperature sensor, sensor short circuit
405	Error internal temperature sensor, sensor breakage
406	Error internal temperature sensor, sensor short circuit

- To clear the error, press >. The main menu appears and the error will be cleared.
- Or press the + or – and the error will also be cleared.
- ① If the error is not fixed, it appears again in the auto-menu.

Display symbol "Battery"

If the battery is low, the battery symbol  is shown in the display in Auto mode.

Display symbol "Heating active"

The symbol  appears when the relay is on.

Reset

- Press + for 30 s. The clock thermostat takes over the device name and the last inputs of P1–P3, comfort, setback and frost protection temperature.



9. Settings via the RAMSES top3 app

Connect the clock thermostat with the mobile end device and the RAMSES top3 app

The clock thermostat can be controlled via Bluetooth using the app. The smartphone or tablet will be connected to the clock thermostat via the integrated Bluetooth module.

- Download the **RAMSES top3** app from the App Store or Google Play Store.



- Use > to go to the submenu **Settings**  on the clock thermostat. The flashing Bluetooth symbol  appears.
- Open the **RAMSES top3** app. The app searches for the available devices; the list of available devices appears.
- Select the desired device and confirm with OK.

RAMSES top3 app



- Settings, device management
App info, operating instructions
- Quick selection
- Device list
- Set temperature, adjustable in increments of 0.2 °C (2 °C – 30 °C)
- Info: device type, external input, serial number, etc.

Quick selection

In the quick selection you can choose between comfort temperature and setback temperature (Eco).

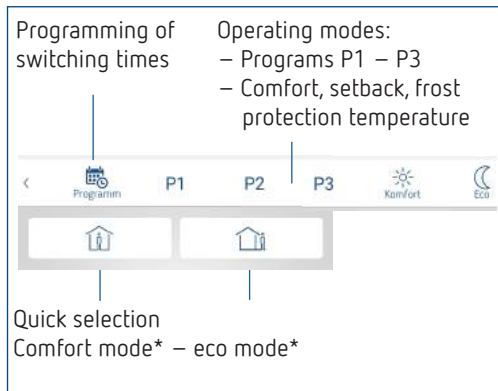

*until the next switching time

Check, change, delete programs P1 – P3



Under **Program** you can

- check, change or delete the pre-programmed weekly programs P1 – P3.
- You can create a new program,
- save a program as a favourite, import it or
- additionally create a holiday program.

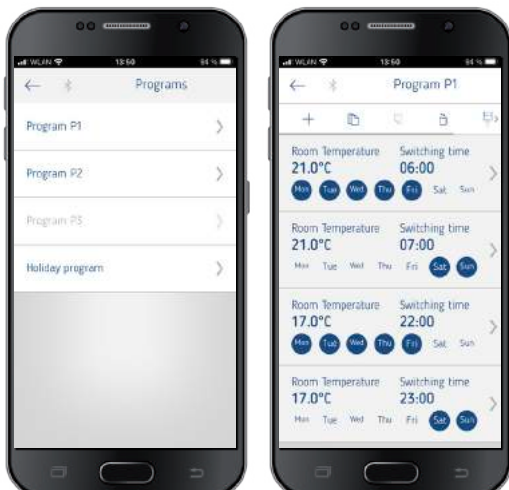

① A maximum of 24 switching times can be set per program, a total of 42.

① During programming, selected days are shown like **Di**, and unselected days like **Mo**.

The created programs are automatically sent to the clock thermostat.

Create a holiday program

In order to create a holiday program and activate it, ▶ slide the controller to "Activate".

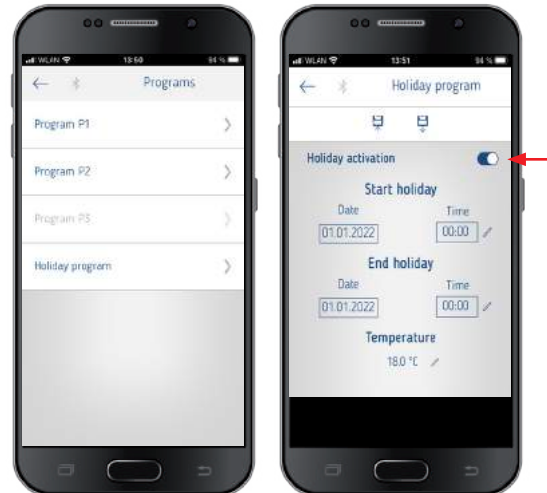

After a holiday program has been created via the app, the clock thermostat receives the following information:

- active/not active
- Start date and end date with time
- Room set temperature during holiday time

① Weekly programs can be stored in the RAMSES top3 app and recalled.

Settings

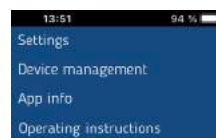

▶ Press **Settings**.
→ The window will open.



① The functions in this submenu have to be set by the qualified electrician.

In the settings, language, temperature (comfort, eco (setback), frost protection), wall compensation, optimisation, etc. can be set.

1. Set wall compensation

See Page 5 above.

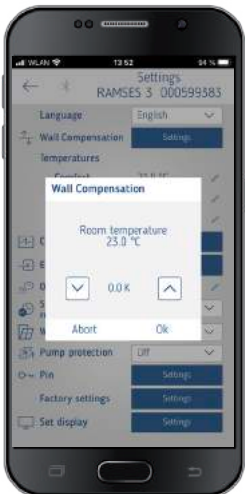

2. Set controller

For the behaviour of a hysteresis controller, see Page 5.
For the behaviour of a pulse duration controller, see Page 5.

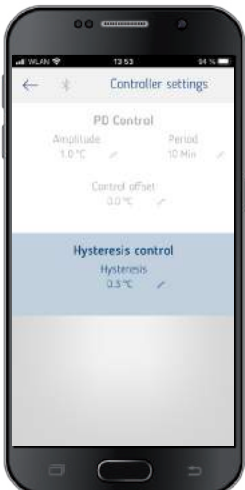

3. External input

The external input can be configured for various external sensors, see Page 6.



Error indicator on RAMSES top3

① If the external input is set to "floor" or "room temperature", an appropriate temperature sensor has to be connected. If this sensor is missing, an error indicator flashes in the device. The same error also appears in the Start menu in the app.

4. Set optimisation

The optimisation function allows you to achieve a certain room temperature at a desired time switch, see Page 6.



5. Set summer / winter time

① The summer / winter time rule for Central Europe is preset (see also Page 7).

You can choose between

- 0 → Off (no summer-winter time changeover)
- 1 → Central Europe (default)
- 2 → Western Europe
- 3 → Eastern Europe



6. Set window detection

Here you can choose between On and Off, for more information see Page 5.



7. Set pump protection

You can switch the pump protection on or off, see Page 7.



8. Teach in HF connection

You can establish the HF connection to a receiver here. A range test is also possible beforehand, see Page 11.



9. PIN

This function allows you to assign or change a new four-digit PIN.



10. Factory settings

Here you can reset all functions to the factory settings.



11. Set display

You can adjust the appearance of your display, see also Page 5.



Device management

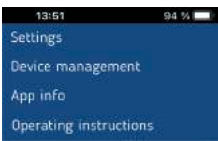

- Edit name
- Delete
- Search for new devices ...
- Device list

In the menu **Device management**, the name can be changed, deleted, etc.

Use + to search for other RAMSES top3 devices.

Info





In the **Info** menu you will find all the information about your RAMSES top3 device (device type, serial number, etc.).

10. Encode RAMSES 813 top3 HF with a new receiver

If you want to connect (encode) a new receiver (REC 1, REC 11) with RAMSES 813 top3 HF – in case the existing device is defective – you should observe the following:

First make the settings at the clock thermostat before you encode it with the receiver.

Connect the clock thermostat to the receiver



- Press > 2 x and go to **Settings** using >. The symbol  flashes.
- Confirm with +.  appears, confirm with >.
- You still have to enter your 4-digit PIN and confirm with >.
- Press > several times and you get to , confirm with +.

The wireless symbol  flashes and the channel is connected to the receiver.

- ⓘ Before you carry out the coding, the receivers must be mounted, connected and the antenna aligned (see below).

Range test for clock thermostat

You can test the range of the HF transmitter by having the device transmit continuously.

- Use + or – to select wireless  → .
- Confirm with +. Off and 1 appear.
- Select 2 (for range test) using >.



- Confirm with +. The process starts. During transmission, 4 dashes are displayed in succession.

Now the clock thermostat sends a signal every 3 s for 15 min. The control indicator on the receiver and the status indicator of the channel light up in this cycle. During the test phase, the location of the thermostat and the reception quality can be optimised. The relays are not switched.

- Place the clock thermostat in the desired living area.



You have optimal reception when all LEDs light up during transmission. At least one green LED should light up.

Finish the range test

- Press + or – to stop sending. Off appears again in the display.
- Using > takes you back to the wireless menu .

Encode the clock thermostat with the receiver

After you have aligned the antenna of the receiver, you can re-teach the connection to the receivers. During the teach-in procedure, 4 dashes appear in the display in succession.

- Use + or – to select wireless  → .
- Confirm with +. Off and 1 appear.



- Confirm with +. The process starts. During transmission, 4 dashes are displayed in succession.

Align the antenna of the receiver

- ① Do not place antenna next to water pipes or electricity cables.
- Connect the receiver to the operating voltage.
- Align the antenna vertically.
- In the event of errors (several LEDs light up), align antenna so that as few LEDs as possible light up.

Encode channel C1 (e. g. room 1)

- ① Delete the old code before you recode the device!
- ① The channels on the receiver must be **off**, i.e. the corresponding LED must be off.

- Press button C1 at the receiver for 5–8 s.
→ The LED of C1 flashes for 5 s. The coding on the thermostat must be completed in this time period by pressing +.

Delete coding

- Press button C1 at the receiver for approx. 10 s.
→ The LED of C1 lights up and goes off after 3 s.

Behaviour in the event of a fault

- ① Since radio signals are electromagnetic waves, the signal from the sender to the receiver is dampened (referred to as transmission range limitation). There are also further interference factors such as metal parts in walls, metal foils used in insulation etc. These create what is known as radio shadow.

Short-term functional failure

The switching status of the relay is not affected because the switch commands are sent several times.

Transmitter failure

The receiver goes into emergency mode after two hours, the relay switches on cyclically for 2 min and off for 8 min.

Mains failure

The relays fall in rest position. The last switching state remains stored and is restored when the mains supply returns. After approx. 30 min, the relays assume their correct switching status.

11. Troubleshooting

Fault	Rectification
Four-digit PIN (password) forgotten	You can force a reset of the device (press + for approx. 30 s). Afterwards, the device PIN is set to 0000 for 5 minutes. During this time you can change the password. After the 5 minutes, the old password or the newly set password is active.
No Bluetooth connection to the device	Make sure that the device is in pairing mode  (only when connecting for the first time, see Page 7), is within range and that your terminal device has Bluetooth enabled. If the problem persists, switch Bluetooth off and on again on your terminal device. If you have problems again, restart your terminal device.
Heating does not occur at the desired time.	Check your active program (P1, P2 or P3) (time and date of the device, switch-on and switch-off times entered correctly, see Page 8). Check the setting of your controller (hysteresis controller, pulse duration controller, see Page 5). Or check the optimisation function (see Page 9).
Log recording does not work. If you use an iPad, the log recording can no longer be displayed when swiping from the left.	Deactivate the "Stage Manager" function in the settings. The log recording is displayed again by swiping.

12. Technical data

Battery devices (8119200, 8139200)

Operating voltage	Batteries: 2 x 1.5 V LR6 AA
Standby power	< 0.2 mW
Power reserve during battery change	10 min
Time accuracy	≤ ± 1 s/day (quartz) at 20 °C
Controller type	Hysteresis controller or pulse duration controller
Type of contact	NO contact (only 8119200)
Switch output	floating
Switching capacity	8119200: 10 A at 250 V AC, cos φ = 1
Mode of operation	Type 1.B (8119200); Type 1 (8139200) according to EN 60730-1
Operating temperature	+ 0 °C ... + 50 °C
Temperature setting range	+ 2 °C ... + 30 °C in increments of 0.2 °C
Memory locations	42
Protection rating	IP 40 according to EN 60529 (for 8119200: IP 20 during battery change)
Protection class	II (8119200) if correctly installed, III (8139200)
Control period	5–30 min (pulse duration controller)
Control capture range	± 0.2 K to 5 K (pulse duration controller)
Switching hysteresis	± 0.2 K to ± 1.0 K (hysteresis controller)
Pollution degree	2

Rated impulse voltage	4 kV (8119200)
Software class	A
Radio frequency/transmission power	BLE 2.4 ... 2.48 GHz, max. 2 dBm; Range in free field: approx. 40 m 8139200: 868 MHz, max. 2 dBm; Range in free field: approx. 100 m

Power supply devices (8120200, 8120210)

Operating voltage	230–240 V AC, + 6% / – 15%, 50 Hz
Standby power	< 0.2 W
Controller type	Hysteresis controller or pulse duration controller
Type of contact	NO contact
Switch output	floating
Switching capacity	8120200: 10 A at 250 V AC, $\cos \varphi = 1$ 8120210: 16 A at 250 V AC, $\cos \varphi = 1$
Power reserve	4 hours
Mode of operation	Type 1.B in accordance with EN 60730-1
Operating temperature	+ 0 °C ... + 50 °C
Temperature setting range	+ 2 °C ... + 30 °C in increments of 0.2 °C
Memory locations	42
Protection rating	IP 40 in accordance with EN 60529
Protection class	II in accordance with EN 60730-1
Control period	5–30 min (pulse duration controller)
Control capture range	± 0.2 K to 5 K (pulse duration controller)
Switching hysteresis	± 0.2 K to ± 1.0 K (hysteresis controller)
Rated impulse voltage	4 kV
Pollution degree	2
Software class	A
Radio frequency/transmission power	BLE 2.4 ... 2.48 GHz, max. 2 dBm; Range in free field: approx. 40 m

Receiver REC 1 (9070461) (868 MHz)

Operating voltage	230 V AC, +10% / – 15%, 50 Hz
Contact	changeover contact potential-free, max. 6 (1) A/250 V AC per channel
Protection rating	IP 20 in accordance with EN 60529
Protection class	II subject to designated installation
Operating temperature	+ 0 °C ... + 50 °C
Mode of operation	Type 1.B in accordance with EN 60730-1
Rated impulse voltage	4 kV
Pollution degree	2
Software class	A

Receiver REC 11 (9070421) (868 MHz)

Operating voltage	230 V AC, +10% / – 15%, 50 Hz
Contact	NO contact floating, 16 (2) A/250 V AC per channel (not for SELV)
Protection rating	IP 20 in accordance with EN 60529
Protection class	II subject to designated installation
Operating temperature	+ 0 °C ... + 50 °C
Mode of operation	Type 1.B in accordance with EN 60730-1
Rated impulse voltage	4 kV
Pollution degree	2
Software class	A

Theben AG herewith declares that this type of radio installation complies with Directive 2014/53/EU. The complete text of the EU Declaration of Conformity is available at the following Internet address:
www.theben.de/red-konformitaet

Cleaning and service

- Only use a dry, soft cloth to clean the device surface.
- Do not use any cleaning agents or solvents.

Disposal

- ⓘ **Battery disposal:** Batteries must not be disposed of in domestic waste! Every consumer is legally obliged to return batteries to retailers or municipal collection points.



Dispose of the device separately from domestic waste at an official collection point.

13. Dimensions diagrams

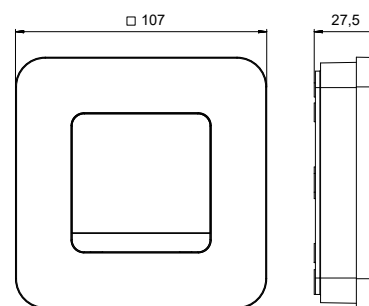

14. Contact

Theben AG
Hohenbergstr. 32
72401 Haigerloch
GERMANY
Phone +49 7474 692-0
Fax +49 7474 692-150

Hotline

Phone +49 7474 692-369
hotline@theben.de

Addresses, telephone numbers, etc.
www.theben.de